



Gerotor Pump & Motor

Aluminum High Speed, Low Torque Series

Catalog HY09-PGG/MGG/US



The Parker Hannifin Gear Pump Division Assures:

- Consistent quality
- Technical innovation
- Premier customer service

Worldwide Sales and Service

Parker operates sales and service centers in major industrial areas worldwide. Call 1-800-C-PARKER for more information, or for a synopsis of the Gear Pump Division, contact a Parker representative.

The Gear Pump Division's ability to engineer specialty products for unique applications has kept us at the forefront of technology, and ensured our position as the industry leader. Our success has come from providing a quality product with excellent sales and service support.

We manufacture hydraulic components for a wide range of industries including:

- Construction
- Refuse/dump truck
- Material handling
- Forestry
- Agriculture
- Industrial



WARNING

FAILURE OR IMPROPER SELECTION OR IMPROPER USE OF THE PRODUCTS AND/OR SYSTEMS DESCRIBED HEREIN OR RELATED ITEMS CAN CAUSE DEATH, PERSONAL INJURY AND PROPERTY DAMAGE.

This document and other information from Parker Hannifin Corporation, its subsidiaries and authorized distributors provide product and/or system options for further investigation by users having technical expertise. It is important that you analyze all aspects of your application and review the information concerning the product or system in the current product catalog. Due to the variety of operating conditions and applications for these products or systems, the user, through its own analysis and testing, is solely responsible for making the final selection of the products and systems and assuring that all performance, safety and warning requirements of the application are met.

The products described herein, including without limitation, product features, specifications, designs, availability and pricing, are subject to change by Parker Hannifin Corporation and its subsidiaries at any time without notice.

Offer of Sale

The items described in this document are hereby offered for sale by Parker Hannifin Corporation, its subsidiaries or its authorized distributors. This offer and its acceptance are governed by the provisions stated in the "Offer of Sale".

© Copyright 2003, Parker Hannifin Corporation, All Rights Reserved.



Table of Contents

GEROTER PUMP & MOTOR:

Specifications for Gerotor Pumps and Motors 3

Ordering Information 4

MGG2 Specifications 5

MGG2 Dimensional Data 6

PGG2 Specifications 7

PGG2 Dimensional Data 8

Designs, Shafts and Mounting Flanges 9

MGG2 Torque and Speed Selection Charts 10

PGG2 Flow, Pressure, Horsepower and RPM 12

Offer of Sale 14

**Specifications
for Gerotor Pumps & Motors**

- Gerotor design (HSLT)*
- Aluminum construction for optimum power to weight ratio
- Bi-directional
- High-pressure mechanical seals available for series application to 1000 PSI back pressure
- Roller bearings for long life
- Buna-N Seals are standard for petroleum and glycol based fluids.
- MGG — Motor
 - Shaft speeds to 5000 RPM
- PGG — Pump
 - Shaft speeds to 3500 RPM
- Up to 17 HP output for motors

**High Speed / Low Torque*

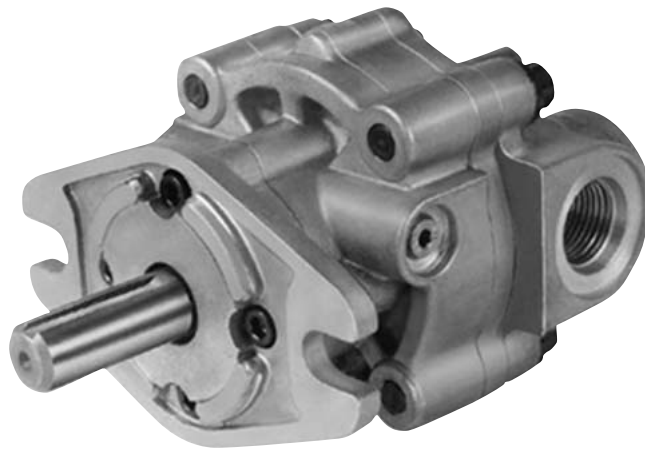

How to Order Gerotor Pumps & Motors:

Select the desired symbol (in the correct position) to construct a model code.

Assembly Example:

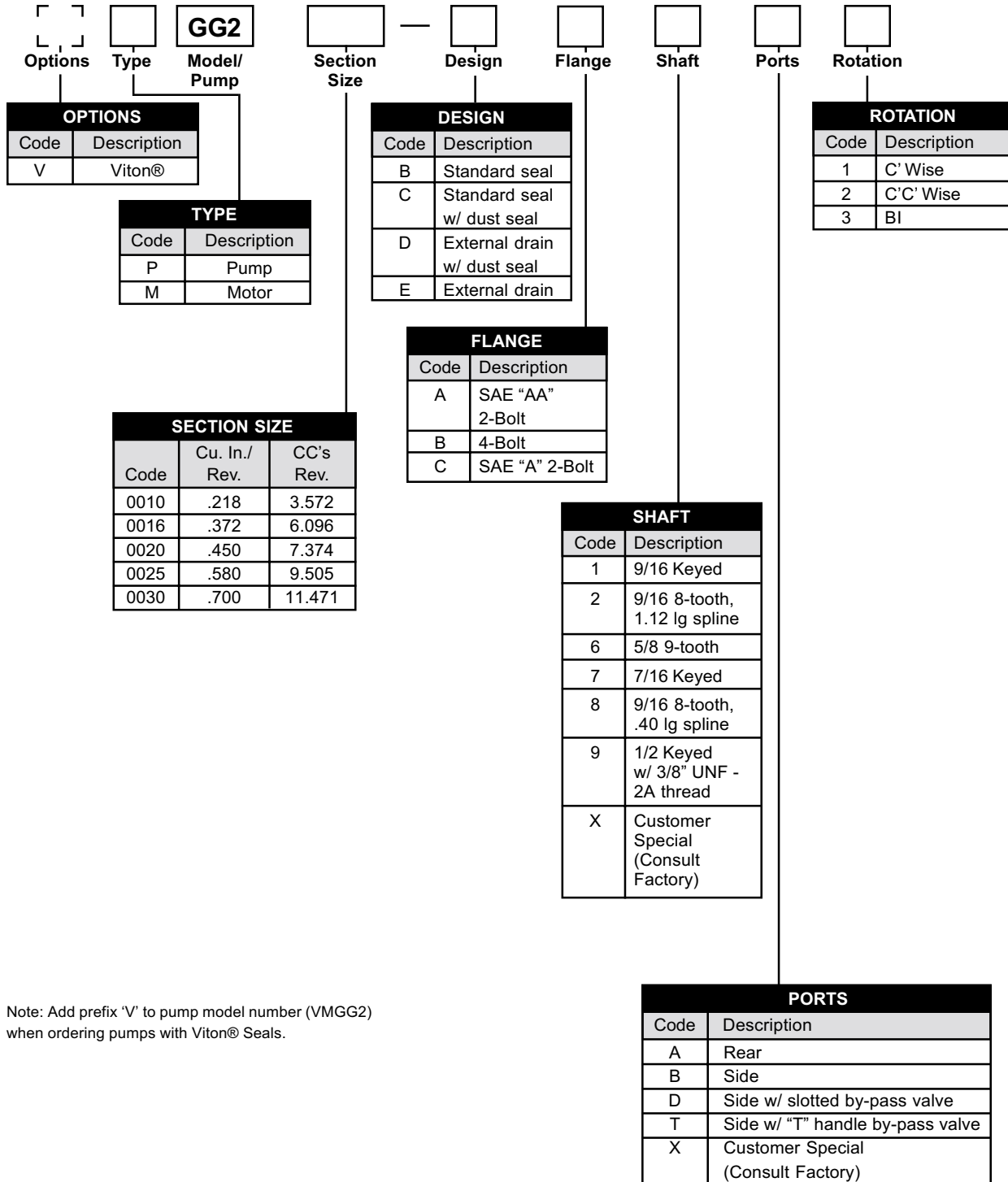

Note: Add prefix 'V' to pump model number (VMGG2) when ordering pumps with Viton® Seals.

**Specifications
for MGG2 Series**

Description Hydraulic Motors
Flow Range To 15 GPM (56.7 LTR)
Displacements To .700 C.I.R.(11.47 CC's/REV.)
Maximum Pressure to 2000 PSI (137 BAR)
Maximum Speed to 5000 RPM
Rotation Bi-Directional
Bearings Roller
Construction Aluminum

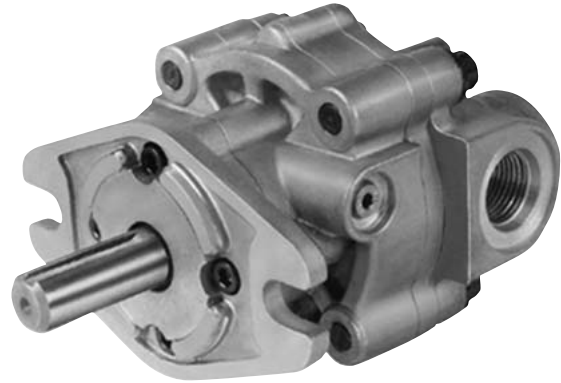

Performance Data

Pump Model	Displacement/Revolution (Theoretical)					Maximum Continuous Pressure		Maximum Speed
	US Gallons	Cubic Inches	Liters	Cubic Centimeters	Imperial Gallons	PSI	BAR	RPM
MGG20010	.0010	.218	.0039	3.572	.0008	2000	138	5000
MGG20016	.0016	.372	.0062	6.096	.0013	2000	138	5000
MGG20020	.0020	.450	.0078	7.374	.0016	2000	138	5000
MGG20025	.0025	.580	.0097	9.505	.0021	2000	138	5000
MGG20030	.0030	.700	.0116	11.471	.0025	1500	104	5000

When used in series circuits, back pressure is not to exceed 1000 (69.0 BAR) PSIG.

MGG Displacement

MODEL NO.	MGG20010	MGG20016	MGG20020	MGG20025	MGG20030
DISPLACEMENT PER REVOLUTION	.218 in. ³ (3.57 cm ³)	.372 in. ³ (6.094 cm ³)	.450 in. ³ (7.374 cm ³)	.580 in. ³ (9.50 cm ³)	.700 in. ³ (11.471 cm ³)
MAXIMUM RATED RPM	5000	5000	5000	5000	5000
RATED FLOW PER 1000 RPM (NOMINAL)	.95 GPM (3.6 liters/min)	1.61 GPM (6.1 liters/min)	1.95 GPM (7.4 liters/min)	2.51 GPM (9.5 liters/min)	3.03 GPM (11.5 liters/min)
MAXIMUM RATED PRESSURE	CONTINUOUS	2000 PSI (138.0 bar)	2000 PSI (138.0 bar)	2000 PSI (138.0 bar)	2000 PSI (138.0 bar)
	INTERMITTENT	2500 PSI (172.5 bar)	2500 PSI (172.5 bar)	2500 PSI (172.5 bar)	2500 PSI (172.5 bar)
OUTPUT TORQUE PER 1000 PSI* (69.0 bar)	35 in.-lbs. (40 kg-cm)	59 in.-lbs. (68 kg-cm)	72 in.-lbs. (83 kg-cm)	92 in.-lbs. (107 kg-cm)	111 in.-lbs. (128 kg-cm)
WEIGHT	2.8 pounds (1.25 kg)	3.0 pounds (1.36 kg)	3.1 pounds (1.41 kg)	3.3 pounds (1.50 kg)	3.5 pounds (1.59 kg)
SHAFT SIDE LOAD**	170 lbs. (77.0 kg)	130 lbs. (59.0 kg)	110 lbs. (50.0 kg)	70 lbs. (31.7 kg)	30 lbs. (13.5 kg)

* THEORETICAL

** SIDE LOAD: Maximum Permissible Shaft Side Load at 2500 RPM and 1000 PSI (69.0 bar) (B-10 Bearing Life of 1000 Hrs.)

OIL TEMPERATURE: Maximum recommended oil temperature 180° F (82.2° C)

OIL VISCOSITY: Recommended viscosity 150 SUS (3.65 engler). (32 centistokes) Minimum recommended viscosity 60 SUS (2.1 engler) (13 centistokes)

FILTRATION: Minimum recommended filtration 10 Micron.

END THRUST: 80 LBS. (36.3 kg.) maximum.

WARNING
Never exceed the INTERMITTENT pressure rating or 5000 RPM

Mounting Dimensions

MODEL NO.	DIMENSIONS		
	'X'	'Y'	'Z'
MGG20010	72.6 (2.86)	91.9 (3.62)	105.7 (4.16)
MGG20016	76.7 (3.02)	96.0 (3.78)	109.7 (4.32)
MGG20020	78.7 (3.10)	98.3 (3.87)	112.0 (4.41)
MGG20025	82.5 (3.25)	101.6 (4.00)	115.3 (4.54)
MGG20030	85.8 (3.38)	105.1 (4.14)	118.9 (4.68)

Inch equivalents for millimeter dimensions are shown in (**).

FLANGE	'W'
2-BOLT 'A-A'	6.3 (.25)
4-BOLT	6.3 (.25)
2-BOLT 'A'	9.5 (.38)

MODEL NO.	'P' STRAIGHT TH'D O-RING PORT PER SAE SPEC. 514d
MGG20010	SAE 8
MGG20016	SAE 8
MGG20020	SAE 8
MGG20025	SAE 10
MGG20030	SAE 10

Cover Plates Available

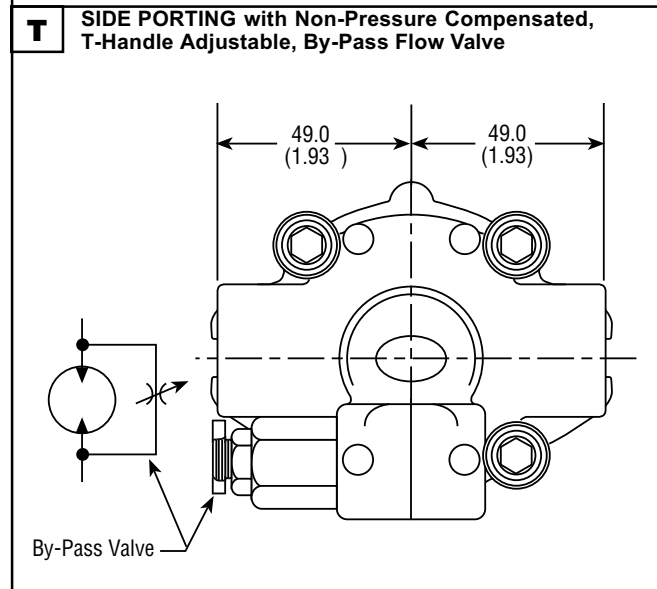
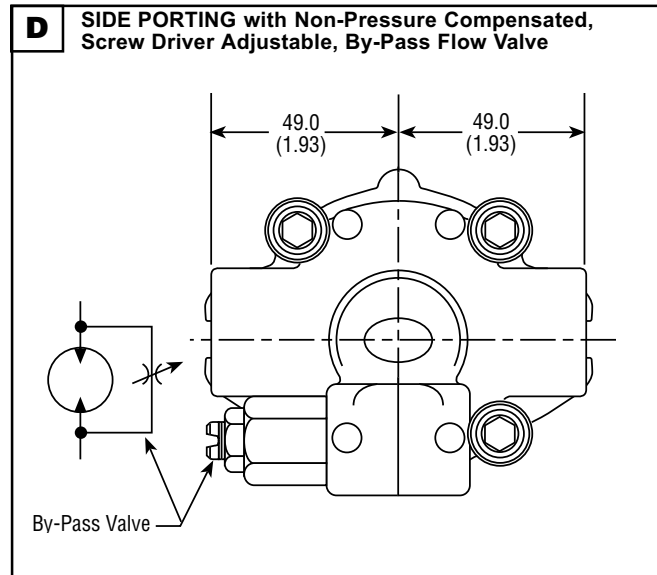
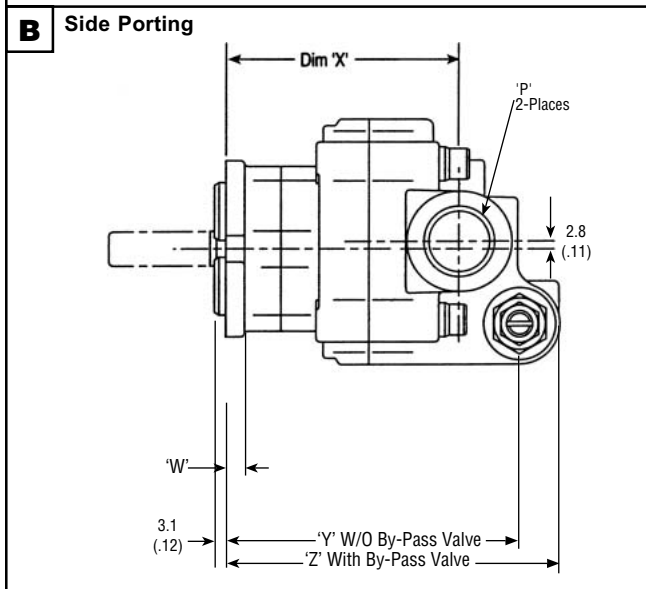
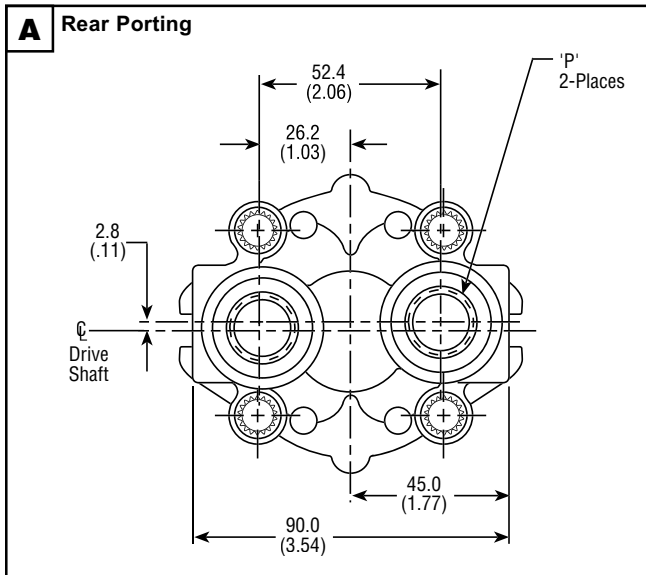

**Specifications
for PGG2 Series**

Description Hydraulic Pumps
Flow Range To 10 GPM (37.8 LTR)
Displacements To .700 C.I.R. (11.47 CC's/REV)
Maximum Pressure to 2000 PSI (138 BAR)
Maximum Speed to 3500 RPM
Rotation Bi-Directional
Bearings Roller
Construction All Aluminum

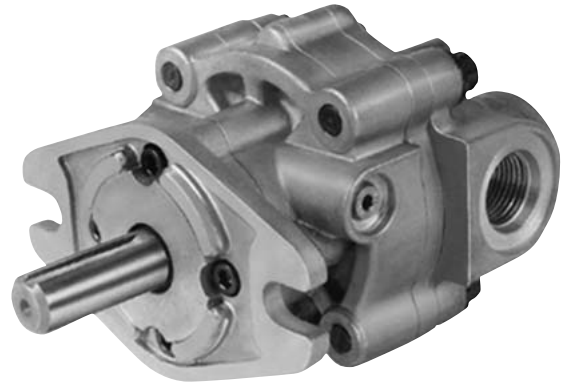

Performance Data

Pump Model	Displacement/Revolution (Theoretical)					Maximum Pressure		Maximum Speed
	US Gallons	Cubic Inches	Liters	Cubic Centimeters	Imperial Gallons	PSI	BAR	RPM
PGG20010	.0010	.218	.0039	3.572	.0008	2000	138	3500
PGG20016	.0016	.372	.0062	6.096	.0013	2000	138	3500
PGG20020	.0020	.450	.0078	7.374	.0016	2000	138	3500
PGG20025	.0025	.580	.0097	9.505	.0021	2000	138	3500
PGG20030	.0030	.700	.0116	11.471	.0025	1500	104	3000

⚠ CAUTION: "Inlet vacuum" should not exceed 5" Hg at normal operating speed and temperature. Operation of pumps in excess of 5" Hg requires factory approval. Back pressure is limited to 20 PSIG maximum.

PGG2 Displacement

MODEL NO.	PGG20010	PGG20016	PGG20020	PGG20025	PGG2003
DISPLACEMENT PER REVOLUTION	.218 in. ³ (3.57 cm ³)	.372 in. ³ (6.096 cm ³)	.450 in. ³ (7.374 cm ³)	.580 in. ³ (9.50 cm ³)	.700 in. ³ (11.471 cm ³)
MAXIMUM RATED RPM	3500	3500	3500	3500	3000
RATED FLOW PER 1000 RPM (NOMINAL)	.95 GPM (3.6 liters/min)	1.61 GPM (6.1 liters/min)	1.95 GPM (7.4 liters/min)	2.51 GPM (9.5 liters/min)	3.03 GPM (11.5 liters/min)
MAXIMUM RATED PRESSURE	2000 PSI (138.0 bar)	2000 PSI (138.0 bar)	2000 PSI (138.0 bar)	2000 PSI (138.0 bar)	1500 PSI (103.5 bar)
	2500 PSI (172.5 bar)	2500 PSI (172.5 bar)	2500 PSI (172.5 bar)	2500 PSI (172.5 bar)	2000 PSI (138.0 bar)
HORSEPOWER HP (KgM/sec)* REQUIRED PER 1000 PSI	.50 HP (38.0 KgM/sec)	.94 HP (71.4 KgM/sec)	1.14 HP (86.6 KgM/sec)	1.46 HP (111.0 KgM/sec)	1.77 HP (134.6 KgM/sec)
WEIGHT	2.8 pounds (1.25 kg)	3.0 pounds (1.36 kg)	3.1 pounds (1.41 kg)	3.3 pounds (1.50 kg)	3.5 pounds (1.59 kg)
SHAFT SIDE LOAD**	170 lbs. (77.0 kg)	130 lbs. (59.0 kg)	110 lbs. (50.0 kg)	70 lbs. (31.7 kg)	30 lbs. (13.5 kg)

* THEORETICAL

** SIDE LOAD: Maximum Permissible Shaft Side Load at 2500 RPM and 1000 PSI (69.0 bar) (B-10 Bearing Life of 1000 Hrs.)

OIL TEMPERATURE: Maximum recommended oil temperature 180° F (82.2° C)

OIL VISCOSITY: Recommended viscosity 150 SUS (3.65 engler). (32 centistokes) Minimum recommended viscosity 60 SUS (2.1 engler) (13 centistokes)

FILTRATION: Minimum recommended filtration 10 Micron.

END THRUST: 80 LBS. (36.3 kg.) maximum.

⚠ WARNING
Never exceed the INTERMITTENT pressure rating or 3500 RPM

Mounting Dimensions

Inch equivalents for millimeter dimensions are shown in (**).

MODEL NO.	DIMENSIONS	
	'X'	'Y'
PGG20010	2.86 (72.6)	3.62 (91.9)
PGG20016	3.02 (76.7)	3.78 (96.0)
PGG20020	3.10 (78.7)	3.87 (98.3)
PGG20025	3.25 (82.5)	4.00 (101.6)
PGG20030	3.38 (85.8)	4.14 (105.1)

FLANGE	'W'
2-BOLT 'A-A'	.25 (6.3)
4-BOLT	.25 (6.3)
2-BOLT 'A'	.38 (9.5)

MODEL NO.	'P' STRAIGHT THREAD O-RING PORT PER SAE SPEC. 514d
PGG20010	SAE 8
PGG20016	SAE 8
PGG20020	SAE 8
PGG20025	SAE 10
PGG20030	SAE 10

Cover Plates Available

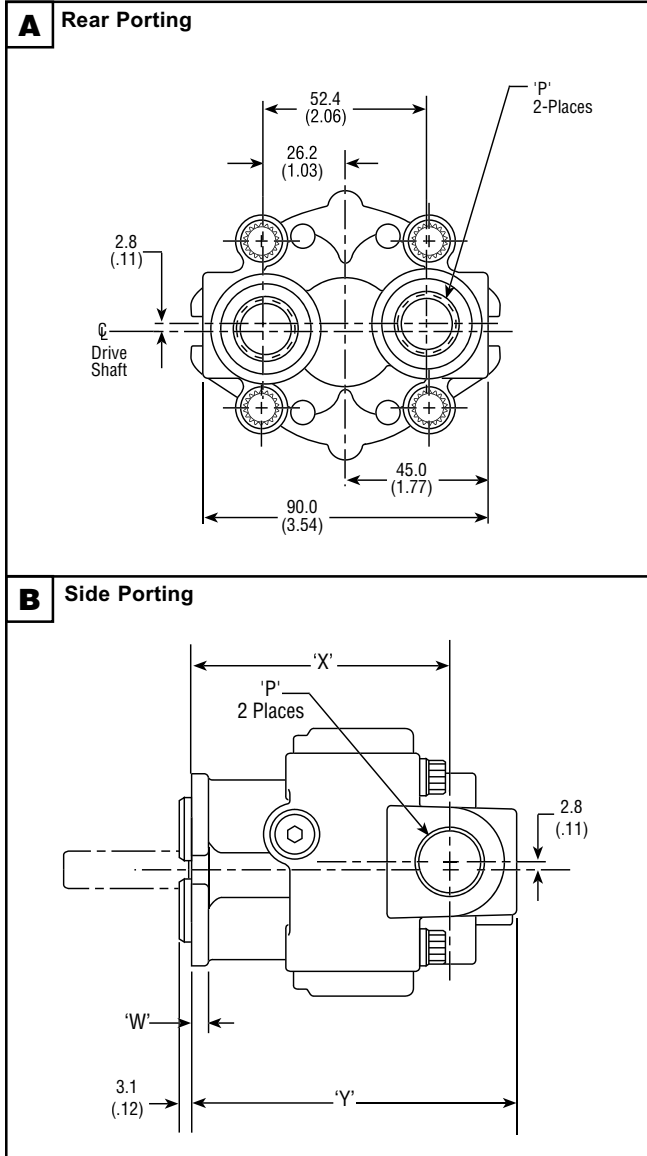

Designs Available

Inch equivalents for millimeter dimensions are shown in (**).

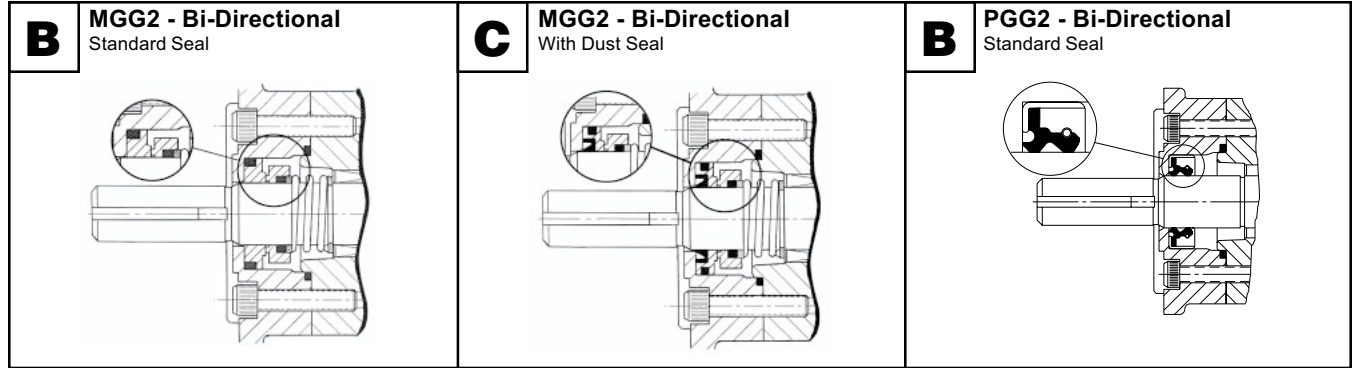

Shafts Available (Consult Factory for Shaft Models Not Listed.)

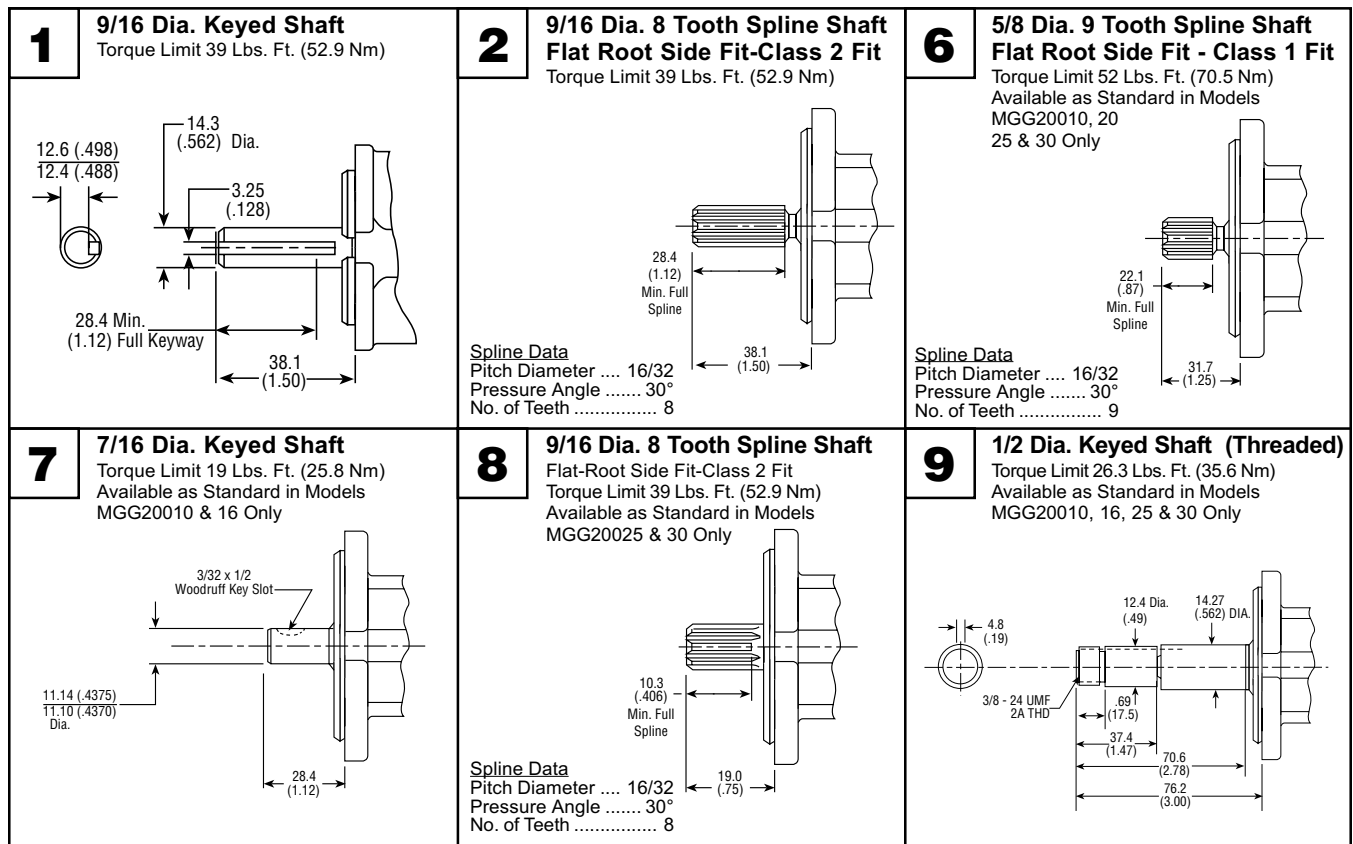

Mounting Flanges Available

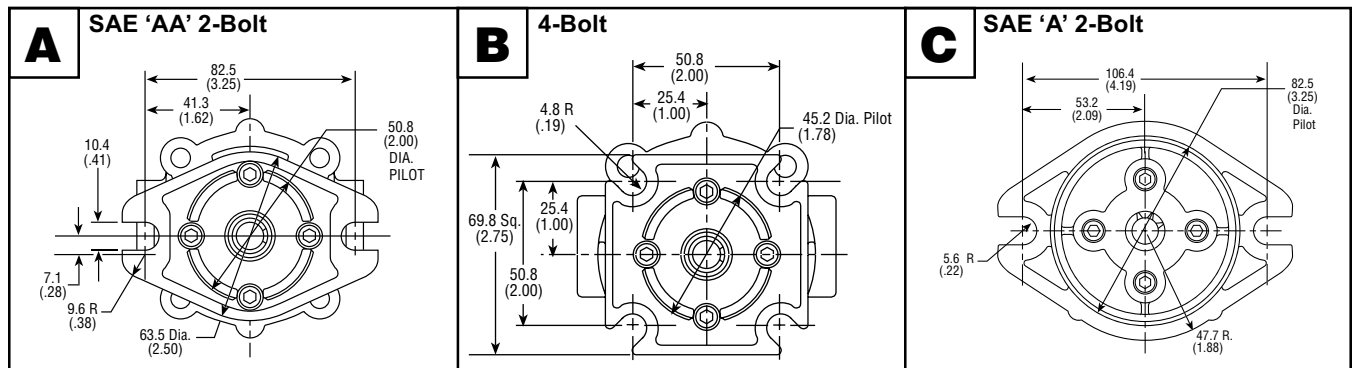

MGG2 Torque and Speed Selection Charts

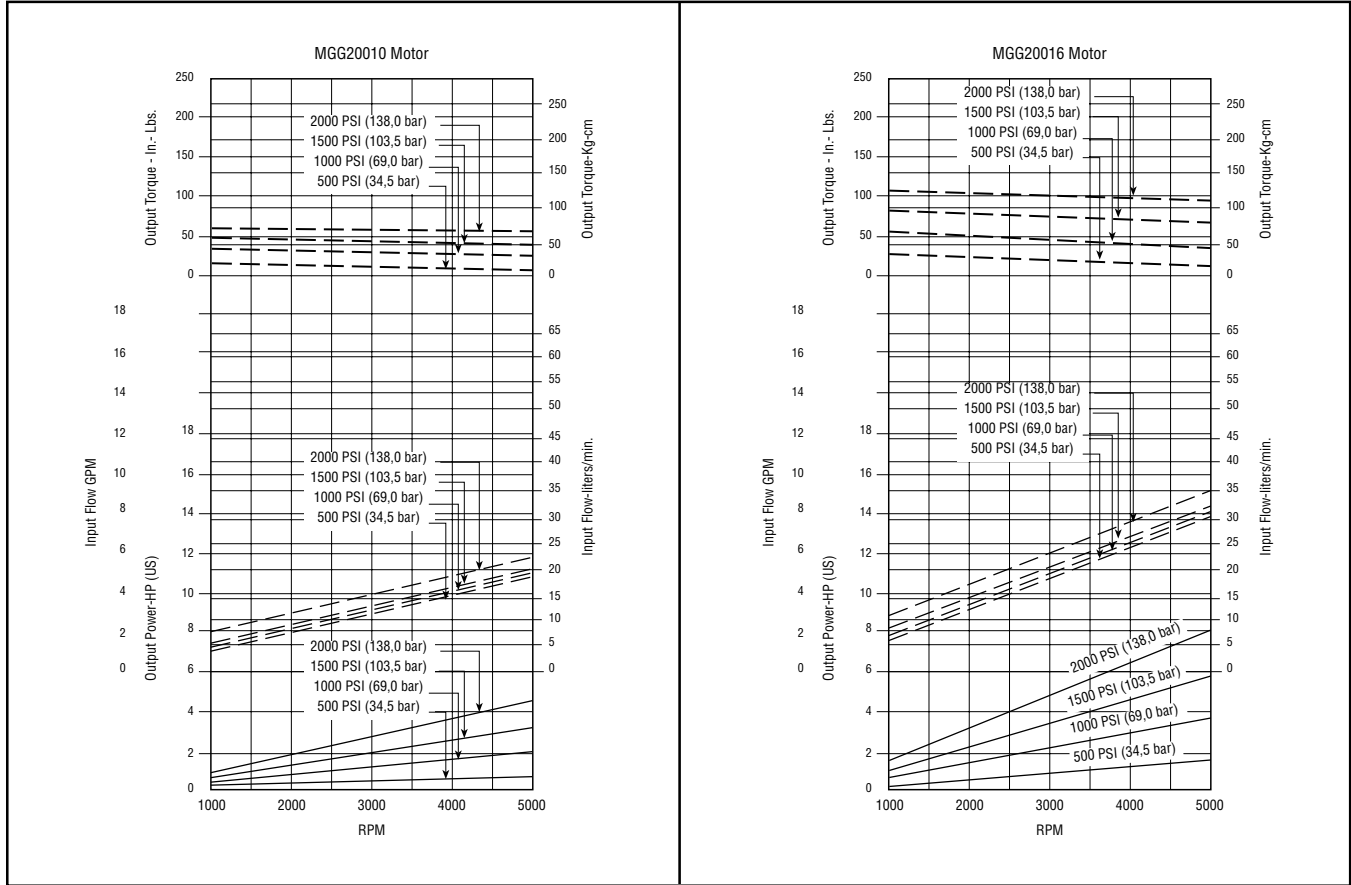

Motor Selection

MGG2 Hydraulic Motors are available in five basic models—each with its own input/output characteristics. To properly select a motor, two things must first be determined—the output torque (inch-pound) that the motor is to produce, and the speed requirement (RPM).

Example: It is required that a motor will deliver an output torque of 150 inch-pounds at a speed of 2500 RPM.

To select the motor (refer to MGG20030 chart):

1. Draw a horizontal line (1) at 150 inch-pounds output torque. The MGG20025 and MGG20030 will both develop the required torque.
2. Draw a vertical line (2) up from 2500 RPM. The point of intersection of the 2 lines indicates the working pressure required at the motor to develop 150 inch-pounds at 2500 RPM.

3. The output horsepower is determined by drawing a horizontal line (3) from the intersection of 2500 RPM and the working pressure required at the bottom of the charts.
4. The input flow to the motor is determined by drawing a horizontal line (4) from the intersection of 2500 RPM and working pressure required in the middle of the chart.

In this example, either the MGG20025 or the MGG20030 can be used. The MGG20025 will develop 150-inch pounds of output torque at 2500 RPM with a pump output (motor input) of 7 GPM at 1800 PSI. The output horsepower is 6.

The MGG20030 will develop 150 inch-pounds of output torque at 2500 RPM with a pump output (motor input) of 8 GPM at 1500 PSI. The output horsepower is 6.

MGG2 Torque and Speed Selection Charts

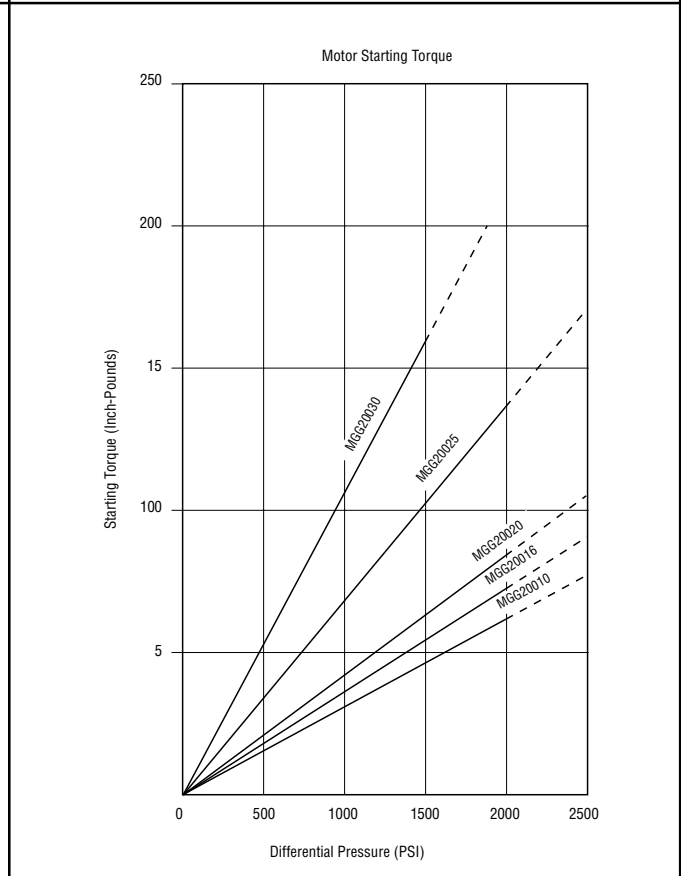
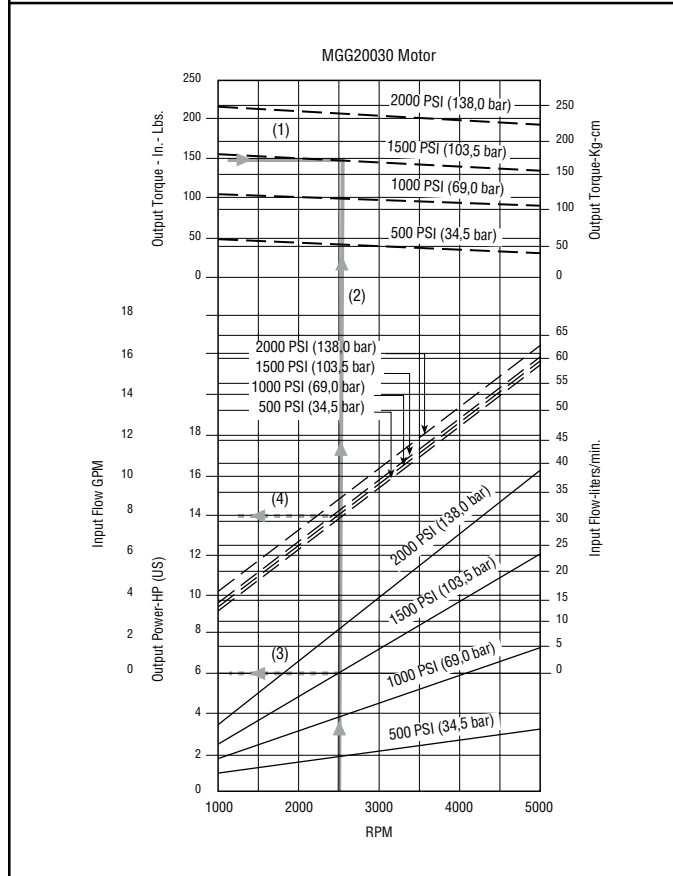
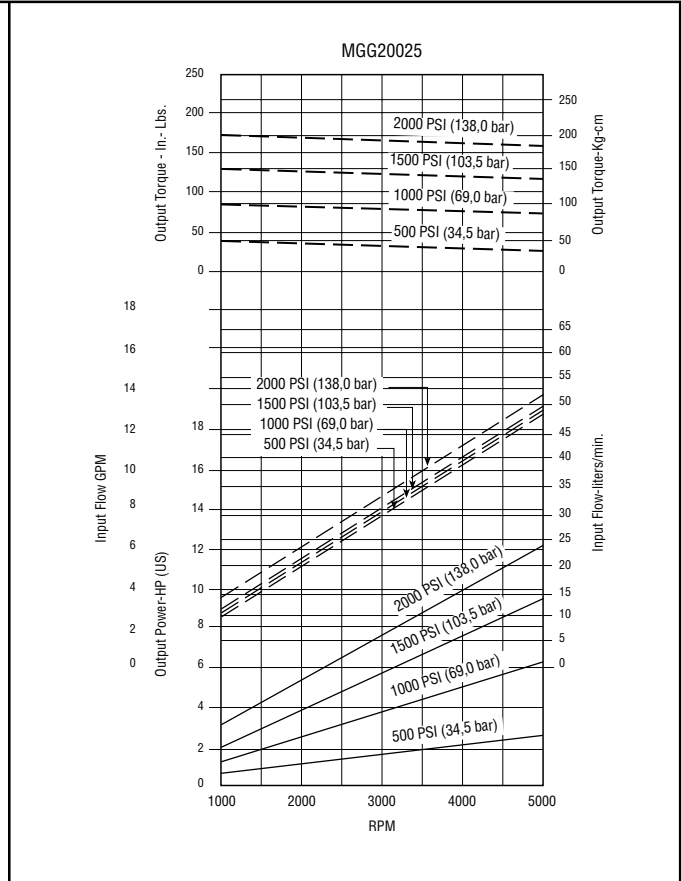
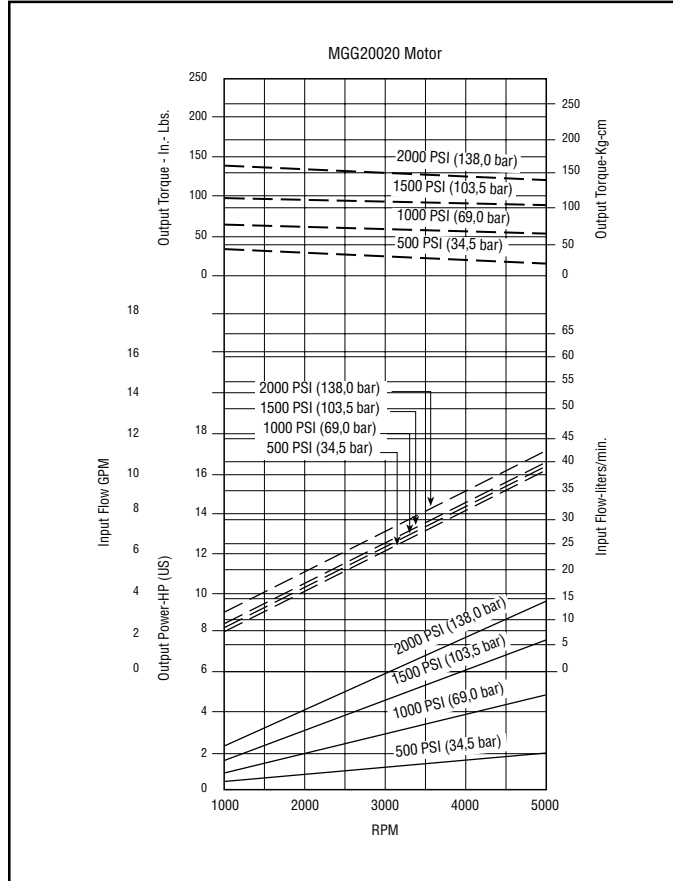

PGG2 Flow, Pressure, Horsepower & RPM Selection Charts

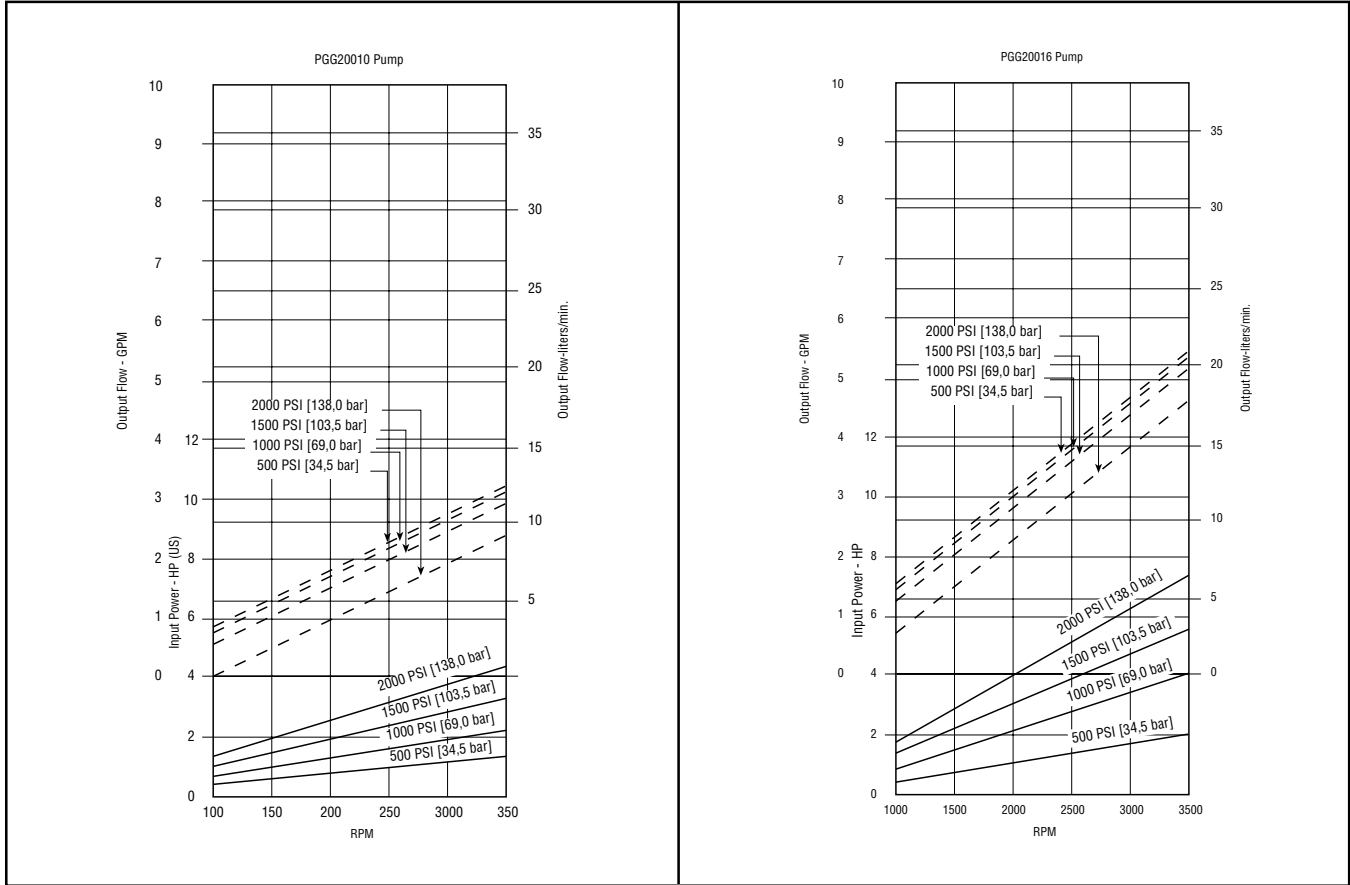

Pump Selection

Hydraulic pumps are available in five basic models—each with its own input/output characteristics. To properly select a pump, four things must first be determined:

1. The desired output flow rate.
2. The maximum continuous pressure in the hydraulic system.
3. The input horsepower required to drive the pump.
4. The RPM at which the pump is to operate.

Example: It is required that a pump deliver 7GPM at 2000 PSI, maximum continuous pressure.

1. From the PGG2 Hydraulic Pump Performance Characteristics Charts, it is shown that only the model PGG20025 delivers 7GPM at a continuous pressure of 2000 PSI. NOTE: PGG20030 is limited to 1500 PSI continuous.
2. Draw line (1) from 7 GPM output flow to where it intersects the line representing 2000 PSI.
3. At the point of intersection, extend line (2) vertically down where it intersects 2000 PSI.
4. By drawing line (3) horizontally across from point of intersection, it is shown that input power requirement is approximately 9.75 HP.
5. By continuing line (4) vertically down, it is shown that input RPM must be 3000.

PGG2 Flow, Pressure, Horsepower & RPM Selection Charts

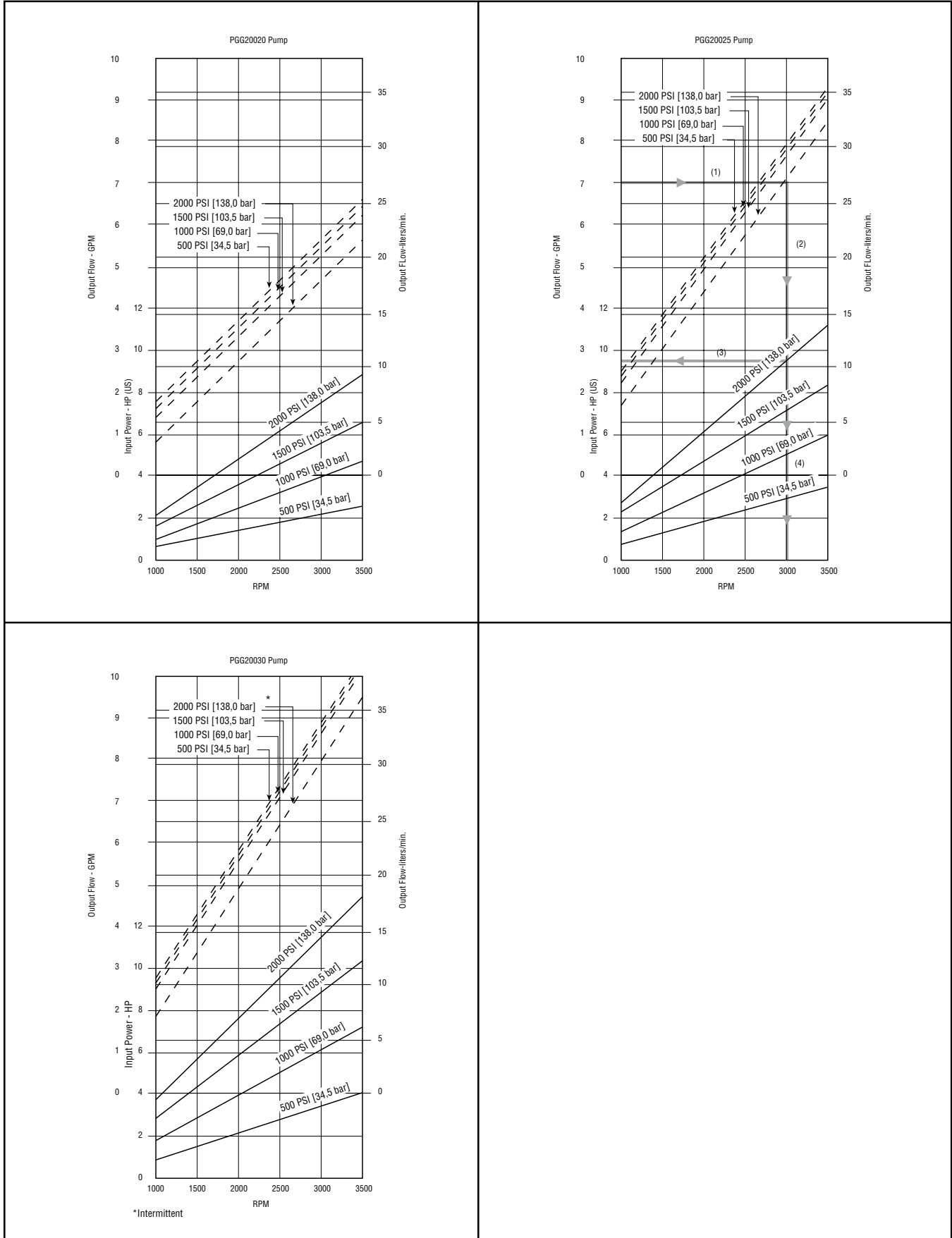

The items described in this document and other documents or descriptions provided by Parker Hannifin Corporation, its subsidiaries and its authorized distributors are hereby offered for sale at prices to be established by Parker Hannifin Corporation, its subsidiaries and its authorized distributors. This offer and its acceptance by any customer ("Buyer") shall be governed by all of the following Terms and Conditions. Buyer's order for any such items, when communicated to Parker Hannifin Corporation, its subsidiary or an authorized distributor ("Seller") verbally or in writing, shall constitute acceptance of this offer.

1. Terms and Conditions of Sale: All descriptions, quotations, proposals, offers, acknowledgments, acceptances and sales of Seller's products are subject to and shall be governed exclusively by the terms and conditions stated herein. Buyer's acceptance of any offer to sell is limited to these terms and conditions. Any terms or conditions in addition to, or inconsistent with those stated herein, proposed by Buyer in any acceptance of an offer by Seller, are hereby objected to. No such additional, different or inconsistent terms and conditions shall become part of the contract between Buyer and Seller unless expressly accepted in writing by Seller. Seller's acceptance of any offer to purchase by Buyer is expressly conditional upon Buyer's assent to all the terms and conditions stated herein, including any terms in addition to, or inconsistent with those contained in Buyer's offer. Acceptance of Seller's products shall in all events constitute such assent.

2. Payment: Payment shall be made by Buyer net 30 days from the date of delivery of the items purchased hereunder. Amounts not timely paid shall bear interest at the maximum rate permitted by law for each month or portion thereof that the Buyer is late in making payment. Any claims by Buyer for omissions or shortages in a shipment shall be waived unless Seller receives notice thereof within 30 days after Buyer's receipt of the shipment.

3. Delivery: Unless otherwise provided on the face hereof, delivery shall be made F.O.B. Seller's plant. Regardless of the method of delivery, however, risk of loss shall pass to Buyer upon Seller's delivery to a carrier. Any delivery dates shown are approximate only and Seller shall have no liability for any delays in delivery.

4. Warranty: Seller warrants that the items sold hereunder shall be free from defects in material or workmanship for a period of 18 months from date of shipment from Parker Hannifin Corporation. **THIS WARRANTY COMPRISES THE SOLE AND ENTIRE WARRANTY PERTAINING TO ITEMS PROVIDED HEREUNDER. SELLER MAKES NO OTHER WARRANTY, GUARANTEE, OR REPRESENTATION OF ANY KIND WHATSOEVER. ALL OTHER WARRANTIES, INCLUDING BUT NOT LIMITED TO, MERCHANTABILITY AND FITNESS FOR PURPOSE, WHETHER EXPRESS, IMPLIED, OR ARISING BY OPERATION OF LAW, TRADE USAGE, OR COURSE OF DEALING ARE HEREBY DISCLAIMED. NOTWITHSTANDING THE FOREGOING, THERE ARE NO WARRANTIES WHATSOEVER ON ITEMS BUILT OR ACQUIRED WHOLLY OR PARTIALLY, TO BUYER'S DESIGNS OR SPECIFICATIONS.**

5. Limitation Of Remedy: SELLER'S LIABILITY ARISING FROM OR IN ANY WAY CONNECTED WITH THE ITEMS SOLD OR THIS CONTRACT SHALL BE LIMITED EXCLUSIVELY TO REPAIR OR REPLACEMENT OF THE ITEMS SOLD OR REFUND OF THE PURCHASE PRICE PAID BY BUYER, AT SELLER'S SOLE OPTION. IN NO EVENT SHALL SELLER BE LIABLE FOR ANY INCIDENTAL, CONSEQUENTIAL OR SPECIAL DAMAGES OF ANY KIND OR NATURE WHATSOEVER, INCLUDING BUT NOT LIMITED TO LOST PROFITS ARISING FROM OR IN ANY WAY CONNECTED WITH THIS AGREEMENT OR ITEMS SOLD HEREUNDER, WHETHER ALLEGED TO ARISE FROM BREACH OF CONTRACT, EXPRESS OR IMPLIED WARRANTY, OR IN TORT, INCLUDING WITHOUT LIMITATION, NEGLIGENCE, FAILURE TO WARN OR STRICT LIABILITY.

6. Changes, Reschedules and Cancellations: Buyer may request to modify the designs or specifications for the items sold hereunder as well as the quantities and delivery dates thereof, or may request to cancel all or part of this order, however, no such requested modification or cancellation shall become part of the contract between Buyer and Seller unless accepted by Seller in a written amendment to this Agreement. Acceptance of any such requested modification or cancellation shall be at Seller's discretion, and shall be upon such terms and conditions as Seller may require.

7. Special Tooling: A tooling charge may be imposed for any special tooling, including without limitation, dies, fixtures, molds and patterns, acquired to manufacture items sold pursuant to this contract. Such special tooling shall be and remain Seller's property notwithstanding payment of any charges by Buyer. In no event will Buyer acquire any interest in apparatus belonging to Seller which is utilized in the notwithstanding any charges paid by Buyer. Unless otherwise agreed, Seller shall have the right to alter, discard or otherwise dispose of any special tooling or other property in its sole discretion at any time.

8. Buyer's Property: Any designs, tools, patterns, materials, drawings, confidential information or equipment furnished by Buyer or any other items which become Buyer's property, may be considered obsolete and may be destroyed by Seller after two (2) consecutive years have elapsed without Buyer placing an order for the items which are manufactured using such property, Seller shall not be responsible for any loss or damage to such property while it is in Seller's possession or control.

9. Taxes: Unless otherwise indicated on the face hereof, all prices and charges are exclusive of excise, sales, use, property, occupational or like taxes which may be imposed by any taxing authority upon the manufacture, sale or delivery of the items sold hereunder. If any such taxes must be paid by Seller or if Seller is liable for the collection of such tax, the amount thereof shall be in addition to the amounts for the items sold. Buyer agrees to pay all such taxes or to reimburse Seller therefore upon receipt of its invoice. If Buyer claims exemption from any sales, use or other tax imposed by any taxing authority, Buyer shall save Seller harmless from and against any such tax, together with any interest or penalties thereon which may be assessed if the items are held to be taxable.

10. Indemnity For Infringement of Intellectual Property Rights: Seller shall have no liability for infringement of any patents, trademarks, copyrights, trade dress, trade secrets or similar rights except as provided in this Part 10. Seller will defend and indemnify Buyer against allegations of infringement of U.S. Patents, U.S. Trademarks, copyrights, trade dress and trade secrets (hereinafter 'Intellectual Property Rights'). Seller will defend at its expense and will pay the cost of any settlement or damages awarded in an action brought against Buyer based on an allegation that an item sold pursuant to this contract infringes the Intellectual Property Rights of a third party. Seller's obligation to defend and indemnify Buyer is contingent on Buyer notifying Seller within ten (10) days after Buyer becomes aware of such allegations of infringement, and Seller having sole control over the defense of any allegations or actions including all negotiations for settlement or compromise. If an item sold hereunder is subject to a claim that it infringes the Intellectual Property Rights of a third party, Seller may, at its sole expense and option, procure for Buyer the right to continue using said item, replace or modify said item so as to make it noninfringing, or offer to accept return of said item and return the purchase price less a reasonable allowance for depreciation. Notwithstanding the foregoing, Seller shall have no liability for claims of infringement based on information provided by Buyer, or directed to items delivered hereunder for which the designs are specified in whole or part by Buyer, or infringements resulting from the modification, combination or use in a system of any item sold hereunder. The foregoing provisions of this Part 10 shall constitute Seller's sole and exclusive liability and Buyer's sole and exclusive remedy for infringement of Intellectual Property Rights.

If a claim is based on information provided by Buyer or if the design for an item delivered hereunder is specified in whole or in part by Buyer, Buyer shall defend and indemnify Seller for all costs, expenses or judgments resulting from any claim that such item infringes any patent, trademark, copyright, trade dress, trade secret or any similar right.

11. Force Majeure: Seller does not assume the risk of and shall not be liable for delay or failure to perform any of Seller's obligations by reason of circumstances beyond the reasonable control of Seller (hereinafter 'Events of Force Majeure'). Events of Force Majeure shall include without limitation, accidents, acts of God, strikes or labor disputes, acts, laws, rules or regulations of any government or government agency, fires, floods, delays or failures in delivery of carriers or suppliers, shortages of materials and any other cause beyond Seller's control.

12. Entire Agreement/Governing Law: The terms and conditions set forth herein, together with any amendments, modifications and any different terms or conditions expressly accepted by Seller in writing, shall constitute the entire Agreement concerning the items sold, and there are no oral or other representations or agreements which pertain thereto. This Agreement shall be governed in all respects by the law of the State of Ohio. No actions arising out of the sale of the items sold hereunder or this Agreement may be brought by either party more than two (2) years after the cause of action accrues.

9/91P



Parker Hannifin Corporation
 6035 Parkland Blvd.
 Cleveland, Ohio 44124-4141
 Telephone: (216) 896-3000
 Fax: (216) 896-4000
 Web site: www.parker.com

Parker Hannifin Corporation

About Parker Hannifin Corporation

Parker Hannifin is a leading global motion-control company dedicated to delivering premier customer service. A Fortune 500 corporation listed on the New York Stock Exchange (PH), our components and systems comprise over 1,400 product lines that control motion in some 1,000 industrial and aerospace markets. Parker is the only manufacturer to offer its customers a choice of hydraulic, pneumatic, and electromechanical motion-control solutions. Our Company has the largest distribution network in its field, with over 7,500 distributors serving more than 350,000 customers worldwide.

Parker's Charter

To be a leading worldwide manufacturer of components and systems for the builders and users of durable goods. More specifically, we will design, market and manufacture products controlling motion, flow and pressure. We will achieve profitable growth through premier customer service.

Product Information

North American customers seeking product information, the location of a nearby distributor, or repair services will receive prompt attention by calling the Parker Product Information Center at our toll-free number: 1-800-C-PARKER (1-800-272-7537). In the UK, a similar service is available by calling 0500-103-203.

The Aerospace Group

is a leader in the development, design, manufacture and servicing of control systems and components for aerospace and related high-technology markets, while achieving growth through premier customer service.



The Climate & Industrial Controls Group

designs, manufactures and markets system-control and fluid-handling components and systems to refrigeration, air-conditioning and industrial customers worldwide.



The Fluid Connectors Group

designs, manufactures and markets rigid and flexible connectors, and associated products used in pneumatic and fluid systems.



The Seal Group designs, manufactures and distributes industrial and commercial sealing devices and related products by providing superior quality and total customer satisfaction.



The Hydraulics Group

designs, produces and markets a full spectrum of hydraulic components and systems to builders and users of industrial and mobile machinery and equipment.



The Filtration Group

designs, manufactures and markets quality filtration and clarification products, providing customers with the best value, quality, technical support, and global availability.



The Automation Group

is a leading supplier of pneumatic and electro-mechanical components and systems to automation customers worldwide.



The Instrumentation Group

is a global leader in the design, manufacture and distribution of high-quality critical flow components for worldwide process instrumentation, ultra-high-purity, medical and analytical applications.





Parker Hannifin Corporation
Gear Pump Division
1775 Logan Avenue
Youngstown, OH 44501 USA
Tel: (330) 746-8011
Fax: (330) 746-1148
<http://www.parker.com/gearpump>

Catalog HY09-PGG/MGG/US,
5M, 10/03, T&M